

# INDEX

Mission

Product Symbols

Warranty

Liners Overview

Sleeves Overview

How To Size Liners And Sleeves

Case Studies

Liners

Sleeves

Locks

Skin Care

Extra

Orthotics

Tel: 727-528-8566 | 800-574-5426 | [www.easyliner.com](http://www.easyliner.com)



## Who We Are

ALPS South is headquartered in St. Petersburg, Florida.

ALPS extends its global presence through their divisions in China, Czech Republic, Italy and Ukraine.

Our silicone expertise began with Dr. Aldo Laghi, ALPS South LLC's President, who was among the original inventors of liquid silicone products and processes at General Electric.

The first ALPS factory opened in 1988 in New York. In 1994, ALPS relocated operations to Florida, to specialize in prosthetics and silicone. Dedication and a strong focus on innovation has led us to register more than 65 patents across several product categories.

# OUR MISSION

## Making Lives Better

The mission at ALPS is to assist in "Making Lives Better," it is this mission that pushes us to provide superior products for all of our customers.

We pride ourselves on conducting business fairly with customers, vendors and employees, while maintaining a brand image that makes employees, customers and vendors proud to be associated with ALPS.



Tel: 727-528-8566 | 800-574-5426 | [www.easyliner.com](http://www.easyliner.com)

# PRODUCT SYMBOLS

## SUSPENSION



Locking Liner



Cushion Liner



Hypobaric suspension

## MATERIAL



**EasyGel:** Contains antioxidants that are an effective scavenger of free radicals and hydroxyl groups. Best for use on amputees with adherent scar tissue, skin irritation, sensitive skin and diabetics.



**Grip Gel:** tackiness helps in reducing bunching in the popliteal area. Best for use on amputees with healthy skin tissue.



**High Density Gel:** the relatively firm nature of the HD Gel combines comfort with control and stability. Best for use on patients who are transitioning from a silicone liner to a gel liner.



Silicone Product



Sensitive Skin Product

## FABRIC



In house knitted fabric with high quality yarns



Black Fabric with highly reduced vertical stretch



Brown Fabric with reduced vertical stretch



Beige Fabric with both horizontal and vertical stretch

## ACTIVITY LEVEL



K1: Low Activity



K2: Middle/Low Activity



K3: Middle/High Activity



K4: High Activity



# ALPS™ Warranty Policy

\*\*All products are backed by a 30 day no questions asked warranty policy

	ITEM	DESCRIPTION	POLICY	
			Single	Pair
<b>LINERS</b>	AKDT(HD)	Extreme Locking Liner	12 Months	24 Months
	AKFR(HD)	Extreme Cushion Liner	12 Months	24 Months
	APDT-TP	Anterior Posterior Tapered Locking Liner	12 Months	24 Months
	APFR-TP	Anterior Posterior Tapered Cushion Liner	12 Months	24 Months
	ELDT	EasyLiner™ Locking Liner	12 Months	24 Months
	ELFR	EasyLiner™ Cushion Liner	12 Months	24 Months
	ELPX	EasyLiner™ Super Stretch	12 Months	
	EZF	EZ Flex Liner	12 Months	24 Months
	ECDTHD	ECO Locking Liner	12 Months	24 Months
	ECFRHD	ECO Cushion Liner	12 Months	24 Months
	GLAK(HD)	Transfemoral Guardian Suction Liner	6 Months	
	GLBK(HD)	Transtibial Guardian Suction Liner	6 Months	
	GL	Cushion Silicone Liner w/o Fabric	12 Months	
	GPDT	General Purpose Locking	12 Months	24 Months
	GPFR	General Purpose Cushion Liner	12 Months	24 Months
	LSL	Silicone Pro Locking Liner	12 Months	24 Months
	LSC	Silicone Pro Cushion Liner	12 Months	24 Months
	PSI	Proximal Seal Interface Liner	6 Months	12 Months
	SADT	Smart Seal Locking Liner	6 Months	
	SAFR/SBFR	Smart Seal Cushion Liner	6 Months	
	SPDT(HD)	Superior Performance Locking Liner	12 Months	24 Months
	SPFR(HD)	Superior Performance Cushion Liner	12 Months	24 Months
	SSA	Silicone Locking Liner	12 Months	
	VSDT	Liberty Liner II Locking Liner	12 Months	24 Months
	<b>SLEEVES</b>	SFB(HD)	Superior Suction Suspension	3 Months
SFK		Extreme Sleeve Fabric Reinforced	3 Months	
SFP(HD)		Superior Performance Sleeve	3 Months	
SFR		EasySleeve Fabric Reinforced	3 Months	
SFS		EasySleeve Fabric Reinforced, Sticky	3 Months	
SFX		Flex Sleeve	3 Months	
SLE		EasySleeve Super Stretch	3 Months	
SL		Silicone Sleeve w/o Fabric	1 Month	
SLR		Silicone Sleeve Fabric Reinforced	3 Months	
SLR CUSTOM		Silicone Sleeve - Custom	3 Months	
VIVA		Valve Integrated Vacuum Activated	3 Months	
<b>LOCKS</b>	S498-P	Alps Lock with Pyramid	6 Months	
	S496-T	Alps Lock Flat Bottom with plate	6 Months	
	S496-W	Alps Lock Flat Bottom without plate	6 Months	
	VIP-DL	VIP - Low Vacuum, Convex	6 Months	
	VIP-DH	VIP - High Vacuum, Convex	6 Months	



# ALPS™ Warranty Policy

\*\*All products are backed by a 30 day no questions asked warranty policy

















SKINCARE	ITEM	DESCRIPTION	POLICY
	ANT-C50	Antioxidant Cream, 50ml Jar	3 Months
	ATP008	Prosthetic Anti-Perspirant	3 Months
	PA604	Prosthetic Lubricant	3 Months
	PD595	Prosthetic Cleaner	3 Months
	PO840	Prosthetic Ointment	3 Months
	SL108	Skin Lotion	3 Months
EXTRAS	ITEM	DESCRIPTION	POLICY
	ENCP	Gel Sheath	1 Month
	KCN, KCM, KCW	Coolmax Sock	1 Month
	PDS	Padsil - Silicone Distal Pad	6 Months
	TSK	Protective Cosmetic Cover	6 Months
ORTHOTICS	ITEM	DESCRIPTION	POLICY
	ABS	Ankle Brace	3 Months
	BB04	Neoprene Back Support	3 Months
	BB06	Back Support	3 Months
	BB08	Lumbosacral Support	3 Months
	CFB-HP	Coolfit Knee Brace, Hinge Pull-On	3 Months
	CFB-HW	Coolfit Knee Brace, Hinge Wrap-Around	3 Months
	FIT-HP	Extended Coolfit Knee, Hinge Pull-On	3 Months
	FIT-HW	Extended Coolfit Knee, Hinge Wrap-Around	3 Months
	KBHP	Knee Brace with Hinges, Pull-On	3 Months
	KBHW	Knee Brace with Hinges, Wrap Around	3 Months
	KBP	Knee Brace w/out Hinges, Pull-On	3 Months
	KBW	Knee Brace w/out Hinges, Wrap Around	3 Months
	TB	Thumb Brace	3 Months
	WB	Wrist Brace	3 Months

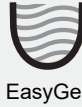

# LINERS OVERVIEW

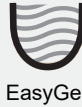

# LINERS OVERVIEW



















Picture	Name	Part #	Type	Material	Thickness	Key Features
	Extreme Liner	AKDT AKDTHD AKFR AKFRHD			Uniform 3 or 6mm	Recommended for AK and high activity BK
	Anterior Posterior Tapered Liner	APDT-TP APFR-TP			Tapered 6 mm anterior to 3mm posterior	Features high performance fabric with gel to assist in reducing popliteal region bunching
	ECO Liner	ECDTHD ECFRHD			Uniform 3 or 6mm	Features a new distal construction with reduced stretch to control distal distraction
	EasyLiner	ELDT ELFR			Uniform 3 or 6mm; Distal- proximal tapered 6/3mm	For patients with sensitive skin  Also available in 9mm for sizes 24 and 28 only
	EasyLiner Super- stretch	ELPX			Uniform 6mm	Without fabric, suitable for difficult cases and sensitive skin
	EasyFlex Liner	EZF			Uniform 3 or 6mm	Front and rear fabric with different elasticity; Flexion comfort

Sensitive  
Skin

Sensitive  
Skin

Sensitive  
Skin

# LINERS OVERVIEW

Picture	Name	Part #	Type	Material	Thickness	Key Features
	Smart Seal Liner	SAFR SADT SBFR		 HD Gel	Uniform 3 or 6mm	Liner with raised bands
	General Purpose Liner	GPDT GPFR		 Grip Gel	Uniform 3 or 6mm	For patients with low activity and healthy skin
	Proximal Seal Interface Liner	PSI		 EasyGel	Uniform 6mm; Distal-proximal tapered 6/3mm	Secure suspension with ALPS sleeves. With proximal sealing interface
	Superior Performance Liner	SPDT SPDTHD SPFR SPFRHD		 Grip Gel HD Gel	Uniform 3 or 6mm	Features a black fabric that allows for comfort and stability. Ideal for active patients
	Liberty Liner	VDST		 HD Gel	Uniform 6mm	Liner with evacuation valve for air expulsion for sweat control
	Silicone PRO	LSC LSL			Uniform 3mm	Alternative from gel. Minimal distal distraction, comfortable fitting and stability for all activity levels

Sensitive Skin



# SLEEVES OVERVIEW



# SLEEVES OVERVIEW

Picture	Name	Part #	Material	Thickness	Key Features
	Superior Suspension Sleeve	SFB SFBHD	Grip Gel HD Gel	Uniform 2mm	2 mm thickness profile for less bulk
	Extreme Sleeve	SFK	Grip Gel	Uniform 3 or 6mm	Limited vertical stretch, ideal for active patients
	Superior Performance Sleeve	SFP SFPHD	Grip Gel HD Gel	Uniform 3 or 6mm	The innovative black fabric provides comfort and stability
	EasySleeve	SFR	EasyGel	Uniform 3 or 6mm	For sensitive skin
	Flex Sleeve	SFX (G) SFX (B)	HD Gel	Uniform 3mm	30° pre-flexed Available in Grey and Beige
	EasySleeve SuperStretch	SLE	EasyGel	Uniform 6mm	Without fabric for freedom of movement
	V.I.V.A	VIVA	Grip Gel	Uniform 3 or 6mm	The built-in valve evacuates the air in the socket

Sensitive Skin

Sensitive Skin

# HOW TO SIZE LINERS

Measure the circumference of the residual limb at 6 cm above the distal end. Use the chart to select the size of the liner.

Example: For a measured circumference of 30 cm, select a 28 size liner.

Circumference	Size
16 - 19 cm	16
20 - 23 cm	20
24 - 25 cm	24
26 - 27 cm	26
28 - 31 cm	28
32 - 37 cm	32
38 - 43 cm	38
44 - 52 cm	44

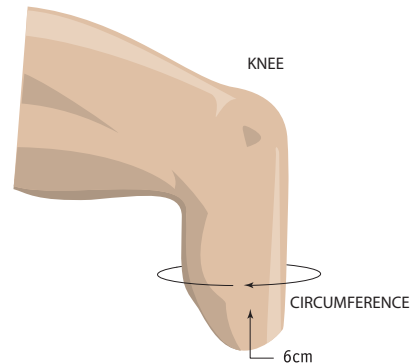

# HOW TO SIZE SLEEVES

Measure the circumference of the leg at 10 cm above the center of the knee. Use the chart to select the size of the sleeve.

Example: For a measured circumference of 32 cm, select a 24 size sleeve.

Circumference	Size
20-24 cm	16
25-30 cm	20
31-34 cm	24
35-37 cm	26
38-40 cm	28
41-45 cm	32
46-60 cm	38
61-70 cm	44

SFX Flex Sleeve	
Circumference	Size
34-37 cm	20
36-39 cm	23
38-42 cm	26
41-46 cm	29
45-50 cm	32

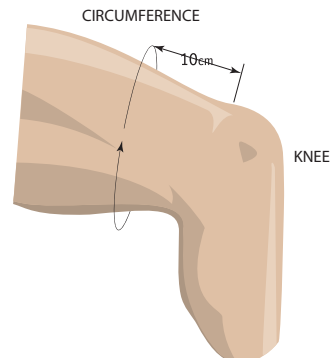

# CASE STUDIES



Alps EasyLiner:

Alps Easyliner contains an antioxidant that is an effective scavenger of free radicals and hydroxyl groups.

Beneficial effects to the skin of patients have been reported.

These stories have been provided here as anecdotal evidence of the benefits that some patients have reported.

## HOW ANTIOXIDANTS WORK

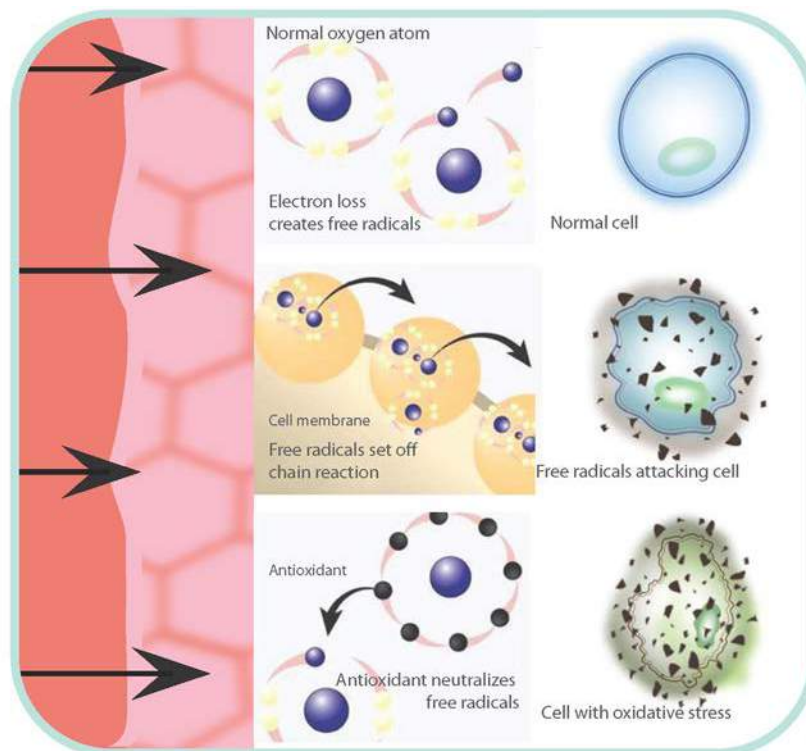

# CASE 1: Diabetic Amputee

This patient is a severe diabetic, insulin dependent with compromised vascularization.

Jim McElhiney evaluated this patient. Jim is a CPO in Nashville (USA), and was contacted by a Tennessee hospital to review this case.

The first two pictures have been taken prior to the fitting by Jim. The patient had been out of her prosthesis for 3 weeks and was being treated with wet and dry dressing. She was then fitted with Alps Easyliner (Cushion Liner) and Alps Easysleeve (Sealing Sleeve), creating a suction suspension system.

Case history provided by: Jim McElhiney, CPO, Nashville (USA).



**Before** the fitting with Alps Easyliner.



**One week** post initial fitting with Alps Easyliner.



**Three weeks** post initial fitting with Alps Easyliner.

## CASE 2: Patient With Dermatitis

This patient has been diagnosed with Contact Dermatitis. He followed the simple cleaning procedures as recommended by the manufacturer.

When that wasn't enough, he started using our product, these were the results.

Case history provided by: Wayne Sadler, CPO, Kentucky (USA).



**Prior** to fitting with Alps EasyLiner.



**One week** post fitting with Alps EasyLiner.

## CASE 3: A Difficult Residual Limb

Case history provided by: Palgi Orthopaedic, Israel.



**Before**, when wearing a silicone liner.



**After**, when fitted with Alps EasyLiner during 4 weeks.



Tel: 727-528-8566 | 800-574-5426 | [www.easyliner.com](http://www.easyliner.com)

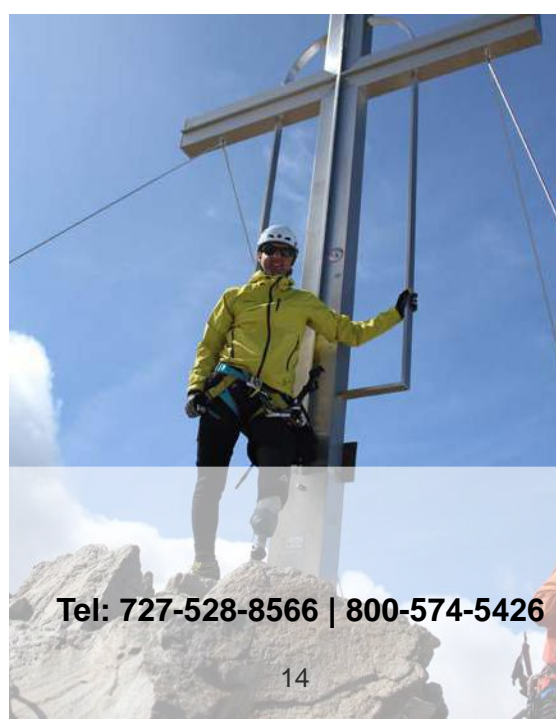

Tel: 727-528-8566 | 800-574-5426 | [www.easyliner.com](http://www.easyliner.com)



# EXTREME LINER

## AKFR / AKFRHD AKDT / AKDTHD

### Features



### Activity Levels



The ALPS Extreme Liner is a prosthetic gel liner specifically designed for transfemoral and active transtibial amputees. It is available in High Density or Grip Gel to satisfy the needs of most patients. ALPS Extreme Liner has 80% less vertical stretch than ALPS other gel liners, which provides more control and stability.

### Features and Applications:

- Offered with High Density or Grip Gel
- Limited vertical stretch reduces movement of redundant tissue and provides greater control of the prosthesis
- High circumferential stretch to assist with form fitting
- Distal ends are proportionate to the size of the liner for ease of donning
- For transfemoral and active transtibial amputees



### Sizing Chart

Measured Size	Locking U	Cushion U
16-19 cm	AKDT(HD)16-(3 or 6)	AKFR(HD)16-(3 or 6)
20-23 cm	AKDT(HD)20-(3 or 6)	AKFR(HD)20-(3 or 6)
24-25 cm	AKDT(HD)24-(3 or 6)	AKFR(HD)24-(3 or 6)
26-27 cm	AKDT(HD)26-(3 or 6)	AKFR(HD)26-(3 or 6)
28-31 cm	AKDT(HD)28-(3 or 6)	AKFR(HD)28-(3 or 6)
32-37 cm	AKDT(HD)32-(3 or 6)	AKFR(HD)32-(3 or 6)
38-43 cm	AKDT(HD)38-(3 or 6)	AKFR(HD)38-(3 or 6)
44-52 cm	AKDT(HD)44-(3 or 6)	AKFR(HD)44-(3 or 6)

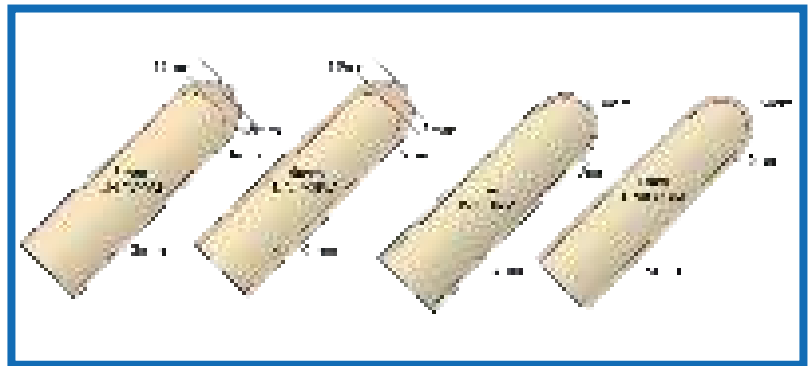

Measure the circumference of the residual limb at 6 cm above the distal end. See page 10 for more info about how to select the size of the liner.

US Patent No. 6,454,812



Tel: 727-528-8566 | 800-574-5426 | [www.easyliner.com](http://www.easyliner.com)





# ANTERIOR-POSTERIOR TAPERED LINER

## APFR-TP / APDT-TP

### Features



### Activity Levels





The ALPS AP Tapered Liner is gradually tapered from the anterior to the posterior to provide superior comfort for the amputee. This liner is available in a pin and lock system or suction suspension. The AP Tapered Liner features our black high performance fabric with gel to assist in reducing bunching in the popliteal region.

### Features and Applications:

- Tapered – 6mm Anterior to 3mm Posterior
- Reduces bunching in the popliteal region
- High performance black fabric



### Sizing Chart

Measured Size	Locking 	Cushion 
20-23 cm	APDT-TP 20-6/3	APFR-TP 20-6/3
24-25 cm	APDT-TP 24-6/3	APFR-TP 24-6/3
26-27 cm	APDT-TP 26-6/3	APFR-TP 26-6/3
28-31 cm	APDT-TP 28-6/3	APFR-TP 28-6/3
32-37 cm	APDT-TP 32-6/3	APFR-TP 32-6/3

Measure the circumference of the residual limb at 6 cm above the distal end. See page 10 for more info about how to select the size of the liner.



US Patent No. 6,454,812



Tel: 727-528-8566 | 800-574-5426 | [www.easyliner.com](http://www.easyliner.com)



# ECO LINER

## ECFRHD / ECDTHD

### Features



### Activity Levels





The ALPS ECO Liner features a new distal construction with reduced stretch to control distal distraction. The ECO Liner has a new seamless knitted construction. It is available in a Locking or Cushion Liner with the ALPS High Density Gel to provide active amputees with a better degree of control.

### Features and Applications:

- Unique distal construction
- Only available in High Density Gel
- Available in 3mm and 6mm uniform thickness



### Sizing Chart

Measured Size	Locking 	Cushion 
20-23 cm	ECDTHD20-(3 or 6)	ECFRHD20-(3 or 6)
24-25 cm	ECDTHD24-(3 or 6)	ECFRHD24-(3 or 6)
26-27 cm	ECDTHD26-(3 or 6)	ECFRHD26-(3 or 6)
28-31 cm	ECDTHD28-(3 or 6)	ECFRHD28-(3 or 6)
32-37 cm	ECDTHD32-(3 or 6)	ECFRHD32-(3 or 6)
38-43 cm	ECDTHD38-(3 or 6)	ECFRHD38-(3 or 6)
44-53 cm	ECDTHD44-(3 or 6)	ECFRHD44-(3 or 6)

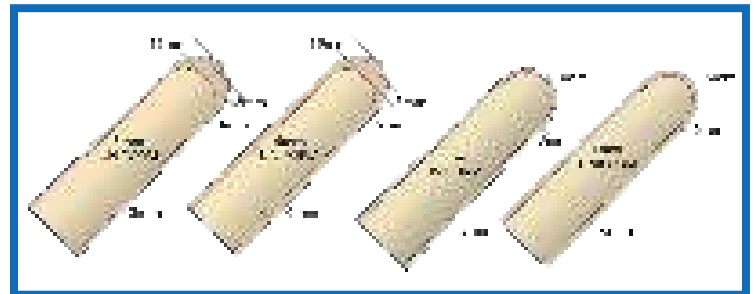

Measure the circumference of the residual limb at 6 cm above the distal end. See page 10 for more info about how to select the size of the liner.

### Covered by one or more of the following

US Patent No. 6,454,812 7,709,570 10,966,845



Tel: 727-528-8566 | 800-574-5426 | [www.easyliner.com](http://www.easyliner.com)



# EASYLINER

## ELFR / ELDT

### Features



### Activity Levels



Sensitive Skin

ALPS EasyLiner is a prosthetic gel liner containing an antioxidant that is an effective scavenger of free radicals and hydroxyl groups, with beneficial effects on the skin of the residual limb. ALPS EasyLiner combines softness, strength, and elasticity from the ALPS EasyGel. This provides the comfort and durability amputees expect. It's our recommended choice for diabetic patients.

### Features and Applications:

- High Performance Fabric improves durability
- Contains antioxidants for use on residual limbs with delicate skin
- The low coefficient of friction relieves the skin of shear forces
- Also available in a tapered version, from 6mm distally to 3mm proximally
- Available in 9mm for sizes 24 and 28 only



### Sizing Chart

Measured Size	Locking U	Cushion U
16-19 cm	ELDT16-(3 or 6 or 6/3)	ELFR16-(3 or 6 or 6/3)
20-23 cm	ELDT20-(3 or 6 or 6/3)	ELFR20-(3 or 6 or 6/3)
24-25 cm	ELDT24-(3, 6, 6/3 or 9)	ELFR24-(3, 6, 6/3 or 9)
26-27 cm	ELDT26-(3 or 6 or 6/3)	ELFR26-(3 or 6 or 6/3)
28-31 cm	ELDT28-(3, 6, 6/3 or 9)	ELFR28-(3, 6, 6/3 or 9)
32-37 cm	ELDT32-(3 or 6 or 6/3)	ELFR32-(3 or 6 or 6/3)
38-43 cm	ELDT38-(3 or 6 or 6/3)	ELFR38-(3 or 6 or 6/3)
44-52 cm	ELDT44-(3 or 6 or 6/3)	ELFR44-(3 or 6 or 6/3)

Measure the circumference of the residual limb at 6 cm above the distal end. See page 10 for more info about how to select the size of the liner.

Covered by one or more of the following US Patent No.  
6,454,812 7,709,570

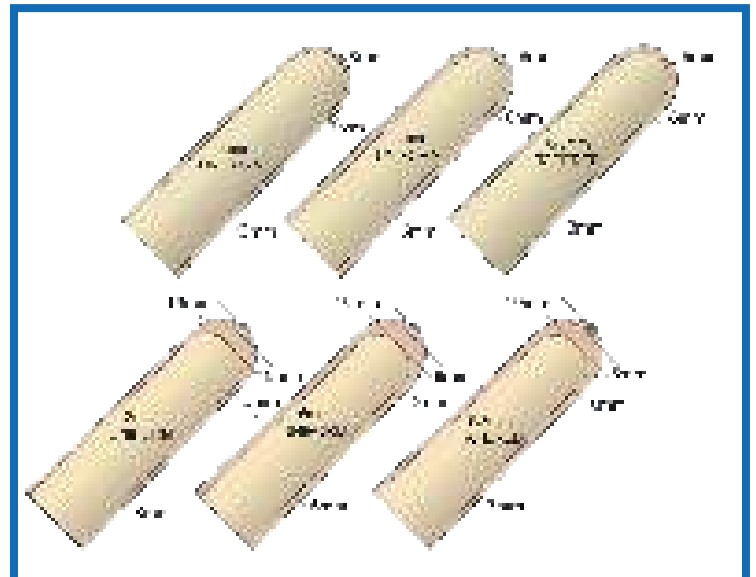

Tel: 727-528-8566 | 800-574-5426 | [www.easyliner.com](http://www.easyliner.com)



# EASYLINER SUPERSTRETCH

## ELPX

### Features



### Activity Levels



Sensitive  
Skin

ALPS EasyLiner SuperStretch is a prosthetic gel liner that combines the softness, strength, and elasticity of the ALPS EasyGel into a gel liner without the restriction of a fabric cover. The ELPX allows complete freedom of movement and achieves superior total contact with the skin without restricting blood flow. The liner also takes advantage of the lower coefficient of friction found only with the EasyGel enabling the skin to be relieved of shear forces.

### Features and Applications:

- Custom fit without the cost or inconvenience
- Contains antioxidants for use on residual limbs with delicate skin
- Available in 6mm uniform thickness
- Longer lengths to accommodate most users



### Sizing Chart

Measured Size	Cushion U
10-15 cm	ELPX10
16-19 cm	ELPX16
20-23 cm	ELPX20
24-25 cm	ELPX24
26-27 cm	ELPX26
28-31 cm	ELPX28
32-37 cm	ELPX32
38-43 cm	ELPX38

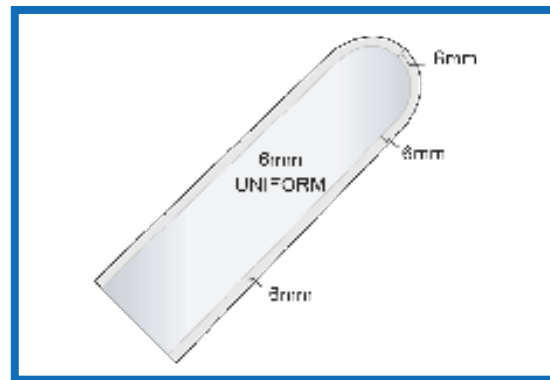

Measure the circumference of the residual limb at 6 cm above the distal end. See page 10 for more info about how to select the size of the liner.

US Patent No. 7,709,570



Tel: 727-528-8566 | 800-574-5426 | [www.easyliner.com](http://www.easyliner.com)



# EASYFLEX LINER

## Features



Sensitive  
Skin

## Activity Levels



## EZF

ALPS prosthetic gel liner EasyFlex allows user ease of knee flexion through an unlimited restriction of stretch anteriorly. Posteriorly the fabric has 80% less vertical stretch which reduces the bunching in the popliteal region. The ALPS EasyGel contains antioxidants that help promote skin health, which also provides comfort and durability.

### Features and Applications:

- Two types of fabric with different elasticity for easier knee flexion
- Distal ends are proportionate to the size of the liner for ease of donning
- Contains antioxidants for use on amputees with delicate skin
- With distal attachment for pin and lock suspension systems



### Sizing Chart

Measured Size	Locking 
16-19 cm	EZF16-(3 or 6)
20-23 cm	EZF20-(3 or 6)
24-25 cm	EZF24-(3 or 6)
26-27 cm	EZF26-(3 or 6)
28-31 cm	EZF28-(3 or 6)
32-37 cm	EZF32-(3 or 6)
38-43 cm	EZF38-(3 or 6)
44-52 cm	EZF44-(3 or 6)

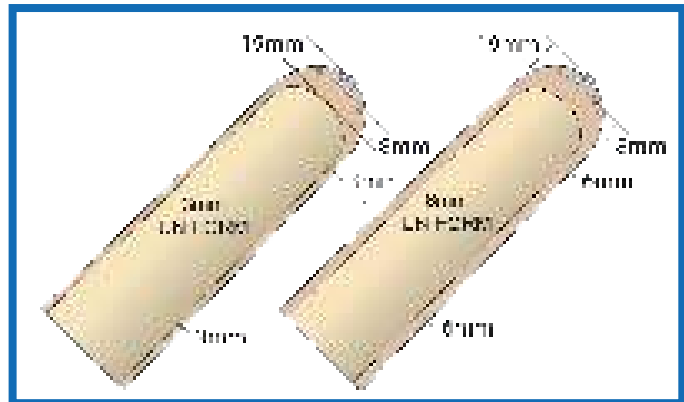

Measure the circumference of the residual limb at 6 cm above the distal end. See page 10 for more info about how to select the size of the liner.

Covered by one or more of the following US Patent No.

6,454,812 8,226,732 7,709,570  
8,246,694 8,349,021



Tel: 727-528-8566 | 800-574-5426 | [www.easyliner.com](http://www.easyliner.com)



# GENERAL PURPOSE LINER

## GPFR / GPDT

### Features



### Activity Levels



The General Purpose prosthetic Gel Liner combines softness, strength, and elasticity from the ALPS Grip Gel. This provides the comfort and durability users expect. The superior elongation from this prosthetic liner does not restrict blood flow in a patient's limb. Also, this liner is easy for a patient to don/doff especially for geriatric lower limb amputees.

### Features and Applications:

- Alps Grip Gel assists in suspension of the prosthesis
- High Performance Fabric improves durability
- Distal end encapsulation retrofits most competitors' liners
- Universal liner, recommended also for geriatric patients



### Sizing Chart

Measured Size	Locking U	Cushion U
16-19 cm	GPDT16-(3 or 6)	GPFR16-(3 or 6)
20-23 cm	GPDT20-(3 or 6)	GPFR20-(3 or 6)
24-25 cm	GPDT24-(3 or 6)	GPFR24-(3 or 6)
26-27 cm	GPDT26-(3 or 6)	GPFR26-(3 or 6)
28-31 cm	GPDT28-(3 or 6)	GPFR28-(3 or 6)
32-37 cm	GPDT32-(3 or 6)	GPFR32-(3 or 6)
38-43 cm	GPDT38-(3 or 6)	GPFR38-(3 or 6)
44-52 cm	GPDT44-(3 or 6)	GPFR44-(3 or 6)

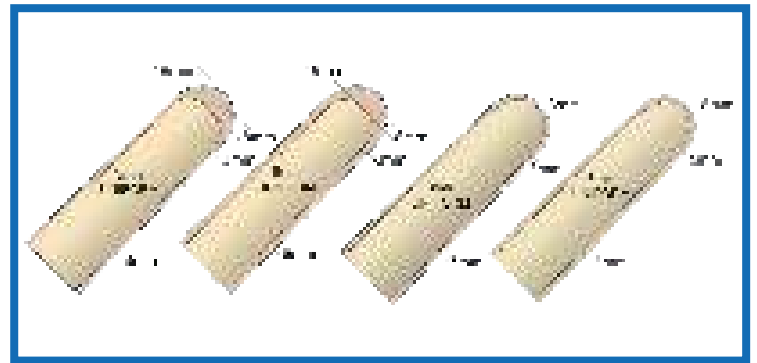

Measure the circumference of the residual limb at 6 cm above the distal end. See page 10 for more info about how to select the size of the liner.

US Patent No. 6,454,812



Tel: 727-528-8566 | 800-574-5426 | [www.easyliner.com](http://www.easyliner.com)



# PROXIMAL SEAL INTERFACE LINER

## PSI

### Features



### Activity Levels



Sensitive  
Skin



ALPS PSI Liner allows the suspension sleeve to seal on the liner just proximal to the trim lines of a transtibial socket. The fabric cover located distally allows the air to wick out of the prosthesis. ALPS EasyGel provides comfort and durability while combining strength, softness, and elasticity. The PSI can be used in conjunction with a current valve suction or vacuum systems being used in the market today.

### Features and Applications:

- Exposed gel portion allows for means of sealing
- Terrycloth fabric located distally to act as air wick
- Works with elevated vacuum systems currently available in the market
- Contains antioxidants for use on amputees with delicate skin



### Sizing Chart

Measured Size	Cushion 6mm 	Cushion 6/3 mm 
16-19 cm	PSI16-6	PSI16-6/3
20-23 cm	PSI20-6	PSI20-6/3
24-25 cm	PSI24-6	PSI24-6/3
26-27 cm	PSI26-6	PSI26-6/3
28-31 cm	PSI28-6	PSI28-6/3
32-37 cm	PSI32-6	PSI32-6/3
38-43 cm	PSI38-6	PSI38-6/3
44-52 cm	PSI44-6	PSI44-6/3

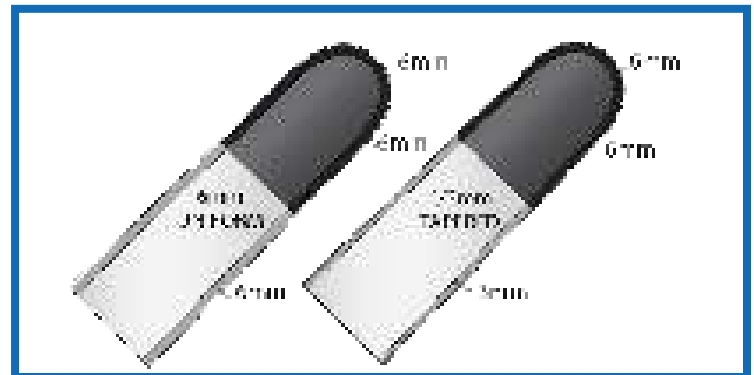

Measure the circumference of the residual limb at 6 cm above the distal end. See page 10 for more info about how to select the size of the liner.

Covered by one or more of the following  
US Patent No.

7,709,570    8,357,206    8,394,150



Tel: 727-528-8566 | 800-574-5426 | [www.easyliner.com](http://www.easyliner.com)



# SMART SEAL LINER

## SAFR / SADT / SBFR

### Features



### Activity Levels





The ALPS Smart Seal Liner features raised bands that grip the socket wall to form a secure interface. The low modulus bands stretch against the socket wall, while the smooth inner wall conforms easily to the residual limb. The Smart Seal Liner has a seamless knitted construction with a modern look and is available in locking and cushion suspension. The locking version features a new distal construction to control distal distraction.

### Features and Applications:

- Rings are coated in silicone which makes it more durable
- Innovative single piece construction
- Only available in High Density Gel
- SAFR: rings begin about 12.5 cm (4.95 in) from the center of the distal end
- SBFR: rings begin about 7.5 cm (3 in) from the center of the distal end
- SADT: sizes 20-30: rings begin about 7.5 cm (3 in) from the center of the distal end
- SADT: sizes 32-38: rings begin about 12.7 cm (4.95 in) from the center of the distal end



### Sizing Chart

Measured Size	Locking 	Cushion 
20-23 cm	SADT20-(3 or 6)	---
24-25 cm	SADT24-(3 or 6)	---
26-27 cm	SADT26-(3 or 6)	SAFR26-(3 or 6)
28-31 cm	SADT28-(3 or 6)	SAFR28-(3 or 6)
32-34 cm	SADT32-(3 or 6)	SAFR32-(3 or 6)
35-37 cm	---	SAFR35-(3 or 6)
38-43 cm	SADT38-(3 or 6)	SAFR38-(3 or 6)



Measure the circumference of the residual limb at 6 cm above the distal end. See page 10 for more info about how to select the size of the liner.



Covered by one or more of the following  
US Patent No. 6,454,812 7,709,570

Tel: 727-528-8566 | 800-574-5426 | [www.easyliner.com](http://www.easyliner.com)





# SUPERIOR PERFORMANCE LINER

SPFR / SPFRHD  
SPDT / SPDTHD

## Features



## Activity Levels





The ALPS Superior Performance prosthetic gel liner is ideal for active amputees. The SP Liner features a black fabric that allows for comfort and stability; it's available with ALPS Grip Gel or with High Density Gel.

### Features and Applications:

- High Performance Fabric for less vertical stretch and increased control of the prosthesis
- Offered with Grip Gel or High Density Gel (HD)
- High circumferential stretch to assist with form fitting
- The HD Gel version is ideal for active amputees and patients transitioning from a Silicone Liner to a Gel Liner



### Sizing Chart

Measured Size	Locking 	Cushion 
16-19 cm	SPDT(HD)16-(3 or 6)	SPFR(HD)16-(3 or 6)
20-23 cm	SPDT(HD)20-(3 or 6)	SPFR(HD)20-(3 or 6)
24-25 cm	SPDT(HD)24-(3 or 6)	SPFR(HD)24-(3 or 6)
26-27 cm	SPDT(HD)26-(3 or 6)	SPFR(HD)26-(3 or 6)
28-31 cm	SPDT(HD)28-(3 or 6)	SPFR(HD)28-(3 or 6)
32-37 cm	SPDT(HD)32-(3 or 6)	SPFR(HD)32-(3 or 6)
38-43 cm	SPDT(HD)38-(3 or 6)	SPFR(HD)38-(3 or 6)
44-52 cm	SPDT(HD)44-(3 or 6)	SPFR(HD)44-(3 or 6)



Measure the circumference of the residual limb at 6 cm above the distal end. See page 10 for more info about how to select the size of the liner.

US Patent No. 6,454,812



Tel: 727-528-8566 | 800-574-5426 | [www.easyliner.com](http://www.easyliner.com)



# LIBERTY LINER II

## VSDT

### Features



### Activity Levels



ALPS Liberty Liner II allows the expulsion of sweat and air through a built-in valve either through the pin or reducer. The one-way evacuation valve has been strategically placed distally to evacuate any air between the user's skin and the liner.

### Features and Applications:

- Provides superior fit
- Built-in valve to expel air
- Liner can be used for pin-lock and suction suspension systems
- Available in 6mm uniform thickness
- Only available in High Density Gel



### Sizing Chart

Measured Size	Locking 
20-23 cm	VSDT20-6
24-25 cm	VSDT24-6
26-27 cm	VSDT26-6
28-31 cm	VSDT28-6
32-37 cm	VSDT32-6
38-43 cm	VSDT38-6

Suggested to be used with:

**LDA-764: Reducer with Built-in Valve**  
**LDP-764: Pin with Built-in Valve**

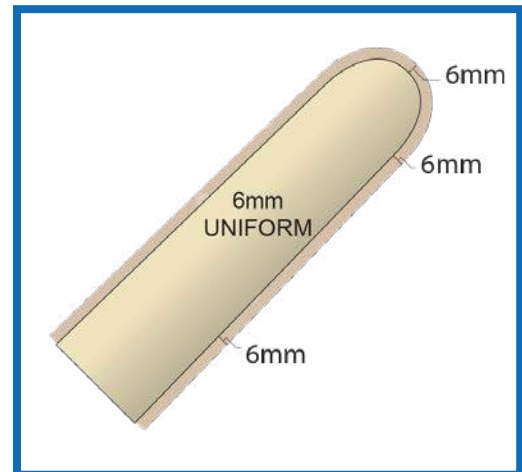

Measure the circumference of the residual limb at 6 cm above the distal end. See page 10 for more info about how to select the size of the liner.

**Covered by one or more of the following US Patent No.**

**6,454,812    7,709,570    10,966,845**



**Tel: 727-528-8566 | 800-574-5426 | [www.easyliner.com](http://www.easyliner.com)**



# CLEAR GEN

## Features



## GL



ALPS Clear Gen is just that, a clear silicone liner. Its transparency allows to properly detect entrapped air and invaginated scars. ALPS Clear Gen is available in 13 sizes for optimum comfort and versatility.

### Features and Applications:

- 1.5mm and 3mm thickness
- 13 standard sizes to accommodate more users
- Optically clear for visual monitoring
- 6 month warranty



### Sizing Chart

Measured Size	GL 1.5mm 	GL 3mm 
14-15 cm	GL14-1.5	GL14-3.0
16-17 cm	GL16-1.5	GL16-3.0
18-19 cm	GL18-1.5	GL18-3.0
20-21 cm	GL20-1.5	GL20-3.0
22-23 cm	GL22-1.5	GL22-3.0
24-25 cm	GL24-1.5	GL24-3.0
26-27 cm	GL26-1.5	GL26-3.0
28-29 cm	GL28-1.5	GL28-3.0
30-31 cm	GL30-1.5	GL30-3.0
32-33 cm	GL32-1.5	GL32-3.0
34-37 cm	GL34-1.5	GL34-3.0
38-43 cm	GL38-1.5	GL38-3.0
44 cm	GL44-1.5	GL44-3.0

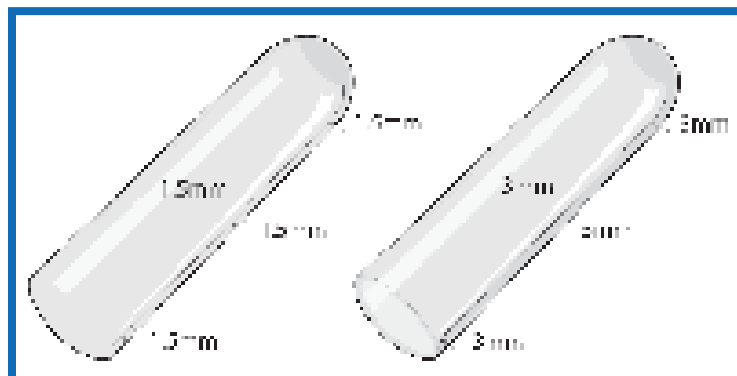

Measure the circumference of the residual limb at 6 cm above the distal end. See page 10 for more info about how to select the size of the liner.



# SILICONE PRO LINER

## LSC / LSL

### Features



### Activity Levels



The ALPS new Silicone Pro liner is coated with ALPS seamless knitted fabric that makes it easy to don and doff. The minimal distal distraction ensures a comfortable fitting and the best stability for all levels of activity.

### Features and Applications:

- One fifth of the friction of regular silicone
- Skin friendly material and thin profile
- Reduced pistoning without distal constraint
- Coated with ALPS knitted fabric for increased freedom of movement
- Lightweight
- Cooling effect



### Sizing Chart

Measured Size	Locking 	Cushion 
20-22 cm	LSL3.0-20	LSC3.0-20
22-24 cm	LSL3.0-22	LSC3.0-22
24-26 cm	LSL3.0-24	LSC3.0-24
26-28 cm	LSL3.0-26	LSC3.0-26
28-30 cm	LSL3.0-28	LSC3.0-28
30-32 cm	LSL3.0-30	LSC3.0-30
32-35 cm	LSL3.0-32	LSC3.0-32
35-38 cm	LSL3.0-35	LSC3.0-35
38-41 cm	LSL3.0-38	LSC3.0-38
41-44 cm	LSL3.0-41	LSC3.0-41
44-47 cm	LSL3.0-44	LSC3.0-44

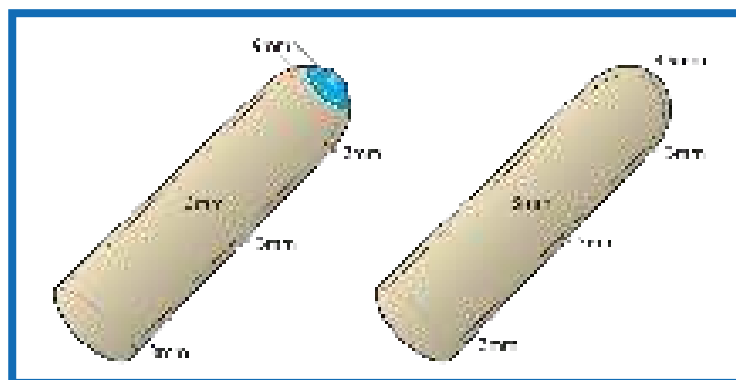

Measure the circumference of the residual limb at 6 cm above the distal end. See page 10 for more info about how to select the size of the liner.





## SSA

ALPS Clearpro is a transparent silicone locking liner that comfortably suspends patients in their prosthesis. Medical grade silicone is used in the Clearpro, which allows freedom of movement with the added comfort of as little as 1.5mm of material behind the knee. It is also designed with additional silicone along the distal end, which provides a gradual transition in reducing pistoning and increasing distal stabilization.

### Features and Applications:

- Medical grade silicone
- Optically clear for visual monitoring
- Increased distal stabilization
- Reduced pistoning
- Available in two different thicknesses: 1.5mm uniform, 3mm uniform



### Sizing Chart

Measured Size	SSA 1.5mm U	SSA 3mm U
14-15 cm	SSA14-1.5	SSA14-3.0
16-17 cm	SSA16-1.5	SSA16-3.0
18-19 cm	SSA18-1.5	SSA18-3.0
20-21 cm	SSA20-1.5	SSA20-3.0
22-23 cm	SSA22-1.5	SSA22-3.0
24-25 cm	SSA24-1.5	SSA24-3.0
26-27 cm	SSA26-1.5	SSA26-3.0
28-29 cm	SSA28-1.5	SSA28-3.0
30-31 cm	SSA30-1.5	SSA30-3.0
32-33 cm	SSA32-1.5	SSA32-3.0
34-37 cm	SSA34-1.5	SSA34-3.0
38-43 cm	SSA38-1.5	SSA38-3.0
44-51 cm	SSA44-1.5	SSA44-3.0

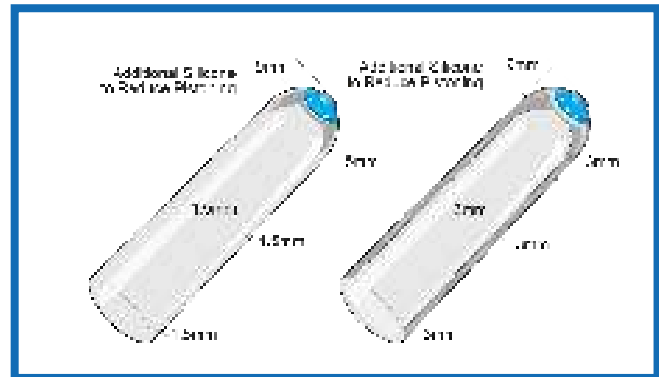

Measure the circumference of the residual limb at 6 cm above the distal end. See page 10 for more info about how to select the size of the liner.

US Patent No. 5,507,834



# SUPERIOR SUSPENSION SLEEVE

## SFB / SFBHD

### Features



### Activity Levels



ALPS Superior Suspension Sleeve has superior comfort provided by ALPS Gel. The SFB features a black knitted fabric that still allows the user excellent freedom of knee flexion. The SFB also achieves secure suspension by sealing with the skin without restricting circulation, while the Gel sticks to the amputee's skin without causing shear forces. With a thinner profile, the SFB is an ideal choice for those concerned about bulk.

### Features and Applications:

- Available with Grip Gel or High Density Gel (HD)
- Available in 2mm uniform thickness
- Freedom of knee flexion
- Provides a secure suspension



### Sizing Chart

Measured Size	2 mm
25-30 cm	SFB(HD)20-2 (S)
31-34 cm	SFB(HD)24-2 (M)
35-37 cm	SFB(HD)26-2 (M+)
38-40 cm	SFB(HD)28-2 (L)
41-45 cm	SFB(HD)32-2 (XL)

Measure the circumference of the leg at 10 cm above the center of the knee. See page 10 for more info about how to select the size of the sleeve.

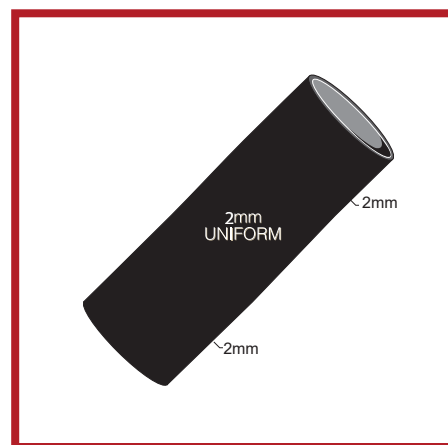

# EXTREME SLEEVE

## SFK

### Features



### Activity Levels



ALPS Extreme Sleeve has superior comfort provided by ALPS Gel. The SFK has limited vertical stretch, and the elasticity of the fabric still allows the user excellent freedom of knee flexion. The Extreme sleeve also achieves secure suspension by sealing with the skin without restricting circulation, while the Grip Gel sticks to the patient's skin without causing shear forces. The Gel will help prevent the sleeve from rolling down the amputee's limb.

### Features and Applications:

- Limited Vertical Stretch
- Freedom of knee flexion
- Minimizes compression and irritation proximally
- Provides a secure suspension



### Sizing Chart

Measured Size	3 mm	6 mm
20-24 cm	SFK16-3 (XS)	SFK16-6 (XS)
25-30 cm	SFK20-3 (S)	SFK20-6 (S)
31-34 cm	SFK24-3 (M)	SFK24-6 (M)
35-37 cm	SFK26-3 (M+)	SFK26-6 (M+)
38-40 cm	SFK28-3 (L)	SFK28-6 (L)
41-45 cm	SFK32-3 (XL)	SFK32-6 (XL)
46-60 cm	SFK38-3 (XXL)	SFK38-6 (XXL)
61-70 cm	SFK44-3 (XXXL)	SFK44-6 (XXXL)

Measure the circumference of the leg at 10 cm above the center of the knee. See page 10 for more info about how to select the size of the sleeve.

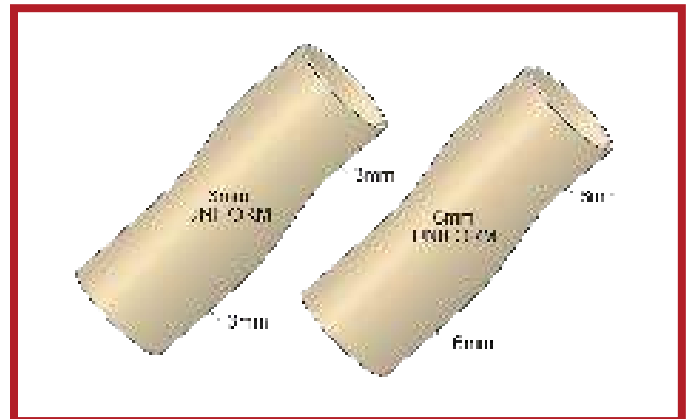

# SUPERIOR PERFORMANCE SLEEVE

## SFP / SFPHD

### Features



### Activity Levels



ALPS Superior Performance Sleeve is a prosthetic gel sleeve constructed with a High Performance black fabric and features ALPS Gel. The SFP has limited vertical stretch, and the horizontal elasticity of the fabric still allows the user excellent freedom of knee flexion. The Gel sticks to the patients skin without causing shear force and help preventing the sleeve from rolling down the amputee's limb.

### Features and Applications:

- Available with High Density Gel (HD) or with Grip Gel
- Available in 3mm and 6mm uniform thickness
- High Performance Fabric for less vertical stretch
- Provides a secure suspension



### Sizing Chart

Measured Size	3 mm	6 mm
20-24 cm	SFP(HD)16-3 (XS)	SFP(HD)16-6 (XS)
25-30 cm	SFP(HD)20-3(S)	SFP(HD)20-6 (S)
31-34 cm	SFP(HD)24-3 (M)	SFP(HD)24-6 (M)
35-37 cm	SFP(HD)26-3 (M+)	SFP(HD)26-6 (M+)
38-40 cm	SFP(HD)28-3 (L)	SFP(HD)28-6 (L)
41-45 cm	SFP(HD)32-3 (XL)	SFP(HD)32-6 (XL)
46-60 cm	SFP(HD)38-3 (XXL)	SFP(HD)38-6 (XXL)
61-70 cm	SFP(HD)44-3 (XXXL)	SFP(HD)44-6 (XXXL)

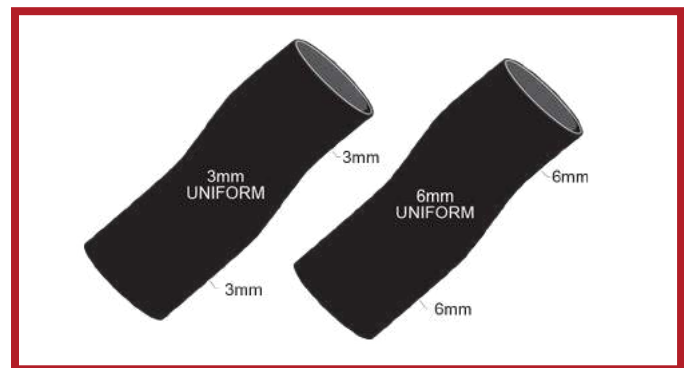

Measure the circumference of the leg at 10 cm above the center of the knee. See page 10 for more info about how to select the size of the sleeve.





# EASYSLEEVE

## SFR

### Features



Sensitive Skin

### Activity Levels



ALPS prosthetic gel sleeve EasySleeve Fabric Reinforced has superior comfort provided by ALPS EasyGel. The elasticity of the fabric still allows the user excellent freedom of knee flexion. The SFR also achieves secure suspension by sealing with the skin without restricting circulation, while the lower coefficient of friction found with the EasyGel helps relieve the skin of shear forces.

### Features and Applications:

- High performance fabric
- Freedom of knee flexion
- Contains antioxidants for use on delicate skin
- Minimizes compression and irritation proximally



### Sizing Chart

Measured Size	3 mm	6 mm
20-24 cm	SFR16-3 (XS)	SFR16-6 (XS)
25-30 cm	SFR20-3 (S)	SFR20-6 (S)
31-34 cm	SFR24-3 (M)	SFR24-6 (M)
35-37 cm	SFR26-3 (M+)	SFR26-6 (M+)
38-40 cm	SFR28-3 (L)	SFR28-6 (L)
41-45 cm	SFR32-3 (XL)	SFR32-6 (XL)
46-60 cm	SFR38-3 (XXL)	SFR38-6 (XXL)
61-70 cm	SFR44-3 (XXXL)	SFR-44-6 (XXXL)

Measure the circumference of the leg at 10 cm above the center of the knee. See page 10 for more info about how to select the size of the sleeve.

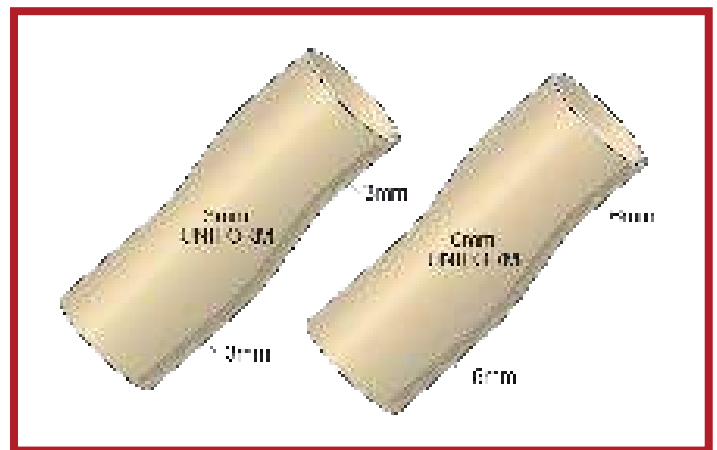

US Patent No. 7,709,570



Tel: 727-528-8566 | 800-574-5426 | [www.easyliner.com](http://www.easyliner.com)



# EASYSLEEVE

## SFS

### Features



### Activity Levels



ALPS SFS has superior comfort provided by GripGel. The elasticity of the fabric allows the user excellent freedom of knee flexion. The SFS also achieves secure suspension by sealing with the skin without restricting circulation, while the GripGel sticks to the patients skin without causing shear force.

### Features and Applications:

- High performance fabric improves durability
- GripGel provides a tacky and secure fit
- Available in 3mm and 6mm uniform thickness



### Sizing Chart

Measured Size	3 mm	6 mm
20-24 cm	SFS16-3 (XS)	SFS16-6 (XS)
25-30 cm	SFS20-3 (S)	SFS20-6 (S)
31-34 cm	SFS24-3 (M)	SFS24-6 (M)
35-37 cm	SFS26-3 (M+)	SFS26-6 (M+)
38-40 cm	SFS28-3 (L)	SFS28-6 (L)
41-45 cm	SFS32-3 (XL)	SFS32-6 (XL)
46-60 cm	SFS38-3 (XXL)	SFS38-6 (XXL)
61-70 cm	SFS44-3 (XXXL)	SFS44-6 (XXXL)

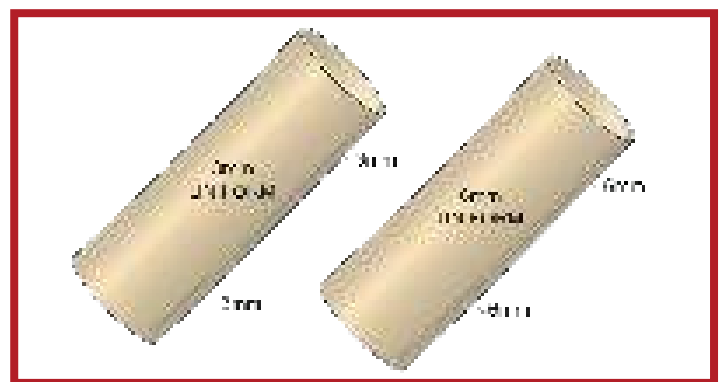

Measure the circumference of the leg at 10 cm above the center of the knee. See page 10 for more info about how to select the size of the sleeve.



# FLEX SLEEVE

## SFX

### Features



### Activity Levels



ALPS Flex Sleeve (SFX) is a prosthetic suspension sleeve made with a seamless knitted construction in High Density Gel to provide maximum comfort. The SFX has a 30° pre-flexion which allows for ease of bending and reduces bunching behind the knee.

### Features and Applications:

- Features a 30° pre-flexion
- HD Gel provides active amputees a great degree of control
- Available in 3mm uniform thickness
- Available in one length that accommodates most users



### Sizing Chart

Measured Size	3 mm Gray	3 mm Beige
34-37 cm	SFX20-3G	SFX20-3B
36-39 cm	SFX23-3G	SFX23-3B
38-42 cm	SFX26-3G	SFX26-3B
41-46 cm	SFX29-3G	SFX29-3B
45-50 cm	SFX32-3G	SFX32-3B

Measure the circumference of the leg at 10 cm above the center of the knee. See page 10 for more info about how to select the size of the sleeve.

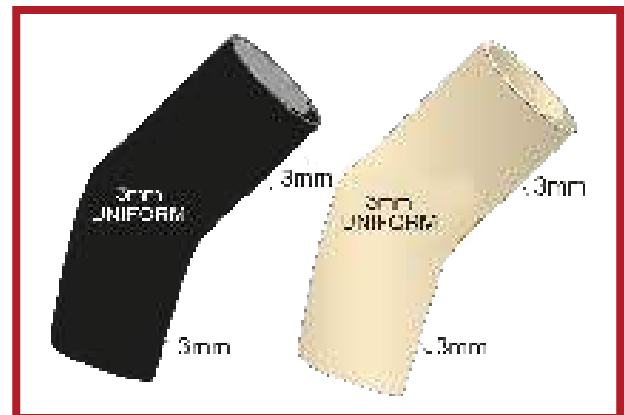

# EASYSLEEVE SUPERSTRETCH

## SLE

### Features



Sensitive  
Skin

### Activity Levels



ALPS EasySleeve SuperStretch is a prosthetic gel sleeve that provides comfort and durability while still providing strength through suction suspension. The SLE allows freedom of knee flexion as well as achieving secure suspension by sealing with the skin without restricting circulation. By using a separate fabric cover, the EasyGel is able to move with the user, therefore reducing the forces against the patella and allowing the bulk of the sleeve to be displaced away from the popliteal area.

### Features and Applications:

- Minimizes compression and irritation proximally
- Longer lengths to accommodate more users
- Contains antioxidants for use on delicate skin
- A fabric cover (sold separately) protects the sleeve
- Recommended for waterproof prosthesis



### Sizing Chart

Measured Size	6 mm	Cover Size
16-19 cm	SLE10 (XXS)	
20-24 cm	SLE16 (XS)	CSLE 16
25-30 cm	SLE20 (S)	CSLE 20
31-34 cm	SLE24 (M)	CSLE 24
35-37 cm	SLE26 (M+)	
38-40 cm	SLE28 (L)	CSLE 28
41-45 cm	SLE32 (XL)	CSLE 32

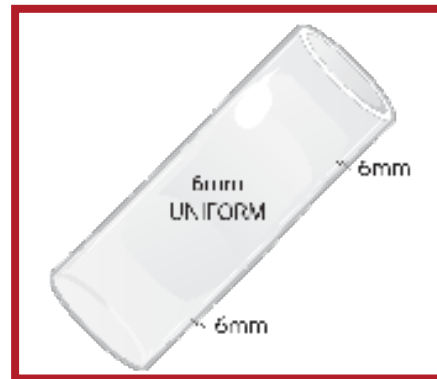

CSLE is available with the EasySleeve Super Stretch as a separate fabric cover.

Measure the circumference of the leg at 10 cm above the center of the knee. See page 10 for more info about how to select the size of the sleeve.

US Patent No. 7,709,570



Tel: 727-528-8566 | 800-574-5426 | [www.easyliner.com](http://www.easyliner.com)



# V.I.V.A.

## VIVA

### Features



### Activity Levels



ALPS VIVA Sleeve is a prosthetic gel sleeve with a built-in valve to evacuate air in the socket to provide superior security. It provides suction suspension without the need of creating a valve in the socket. Once the sleeve is donned, the valve should be located proximal to the patella to create back pressure with knee flexion. The VIVA is made with ALPS Grip Gel which prevents the sleeve from rolling down on the amputee's limb.

### Features and Applications:

- Minimizes compression and irritation proximally
- Freedom of knee flexion
- Built in valve to evacuate air
- Provides a secure suspension
- Can be used with valve in socket for extra air control

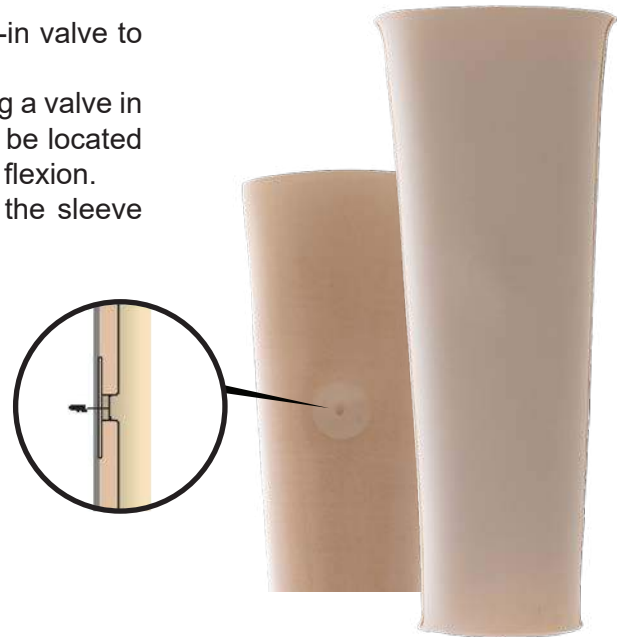

### Sizing Chart

Measured Size	3 mm	6 mm
20-24 cm	VIVA16-3 (XS)	VIVA16-6 (XS)
25-30 cm	VIVA20-3 (S)	VIVA20-6 (S)
31-34 cm	VIVA24-3 (M)	VIVA24-6 (M)
35-37 cm	VIVA26-3 (M+)	VIVA26-6 (M+)
38-40 cm	VIVA28-3 (L)	VIVA28-6 (L)
41-45 cm	VIVA32-3 (XL)	VIVA32-6 (XL)

Measure the circumference of the leg at 10 cm above the center of the knee. See page 10 for more info about how to select the size of the sleeve.

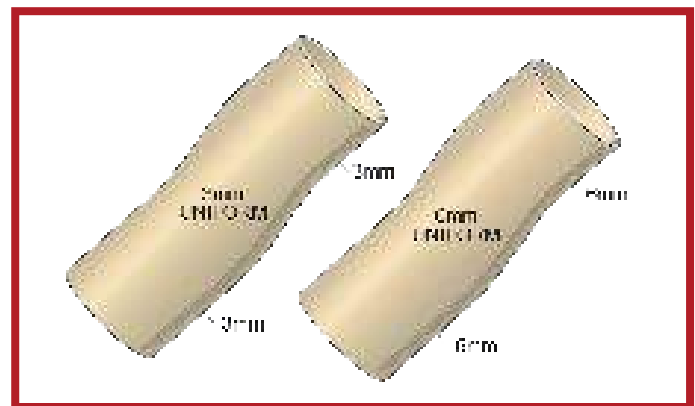

US Patent No. 6,361,568



Tel: 727-528-8566 | 800-574-5426 | [www.easyliner.com](http://www.easyliner.com)



# REINFORCED CLEARLINE

Features



## SLR

ALPS SLR is made with thin silicone and achieves a secure suspension by sealing with the skin. It is one of the few suspension sleeves on the market that can be made custom, allowing more sizing options for practitioners. It is also available in multiple colors.

### Features and Applications:

- Integrated fabric
- Standard and custom sizes available
- Available in 1.5mm uniform thickness



### Sizing Chart

Measured Size	1.5mm Uniform	Color
Smaller than 28 cm	Custom	Black, Nude (Brown), Beige
28-32 cm	SLR-S	Black, Nude (Brown), Beige
33-34 cm	SLR-M	Black, Nude (Brown), Beige
35-37 cm	SLR-L	Black, Nude (Brown), Beige
38-40 cm	SLR-XL	Black, Nude (Brown), Beige
41-45 cm	SLR-2XL	Black, Nude (Brown), Beige
46-51 cm	SLR-3XL	Black, Nude (Brown), Beige
52-57 cm	SLR-4XL	Black, Nude (Brown), Beige
58-64 cm	SLR-5XL	Black, Nude (Brown), Beige
Greater than 64 cm	Custom	Black, Nude (Brown), Beige



Measure the circumference of the leg at 10 cm above the center of the knee. See page 10 for more info about how to select the size of the sleeve.



Tel: 727-528-8566 | 800-574-5426 | [www.easyliner.com](http://www.easyliner.com)



# LOCK WITH FLAT BOTTOM

## S496-W / S496-T

Activity Levels



The ALPS Lock Flat Bottom has shown proven reliability and smooth operation. This lightweight locking device made of glass reinforced nylon exhibits better wear characteristics than delrin or aluminum. The convenient one-way gear allows the user to push in or wind out the limb into the prosthetic socket. A unique feature of this lock is that if foreign material or clothing get caught in the gear, the housing can be removed, freeing the pin. Can be used on both laminations and thermoplastics.

### Features and Applications:

- For laminated or thermoplastic sockets
- Lightweight (107gr)
- The housing can be removed, freeing the pin
- No weight limit
- Infinite pin adjustment reduces play



Glass reinforced nylon main body



LDP-695  
Stainless steel serrated pin

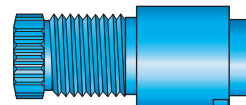

LDH-694A  
Locking mechanism (clutch)

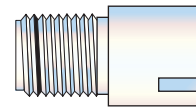

Dummy



LDA-694  
Hex nut adapter



UMP-496  
Universal Mounting Plate



Stainless Steel Screws  
(Sold with Mounting Plate)



3/4" Stainless Steel  
Socket Head Cap Screws  
(Sold with Mounting Plate)

Product Number	Description
S496 - T	Flat Bottom - With Plate
S496 - W	Flat Bottom - Without Plate
FAB - 946	Fabrication Kit
LDA - 694	Hex Nut Adapter
	Dummy

Product Number	Description
LDH - 694 A	Locking Mechanism
LDP - 695	Serrated Pin
LDA - 694	Hex Nut Adapter
UMP - 16	Universal Mounting Plate Only
UMP - 496	Universal Mount Plate Kit



Tel: 727-528-8566 | 800-574-5426 | [www.easyliner.com](http://www.easyliner.com)



# LOCK WITH PYRAMID

## S498-P

Activity Levels



The ALPS Lock with Pyramid is an all-in-one lock body design which combines the lock and pyramid. The glass reinforced nylon lock body exhibits better wear characteristics than delrin or aluminum. The convenient one-way gear allows the user to push in or wind out the limb into the prosthetic socket. A unique feature of this lock is that if foreign material or clothing get caught in the gear, the housing can be removed, freeing the pin. Can be used on laminations, **not thermoplastics**.

### Features and Applications:

- For laminated sockets
- All-in-one lock body design combining the lock and pyramid
- Infinite pin adjustment reduces play
- The housing can be removed, freeing the pin
- 100 kg (220 lbs) weight rating



Glass reinforced nylon main body



LDP-695  
Stainless steel serrated pin

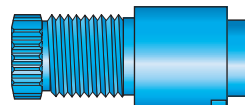

LDH-694A  
Locking mechanism (clutch)

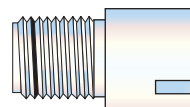

Dummy



LDA-694  
Hex nut adapter

Covered by one or more of the following US Patent No.  
5,507,837

Product Number	Description
S498 - P	Main Body With Pyramid
LDH - 694 A	Locking Mechanism
LDP - 695	Serrated Pin
LDA - 694	Hex Nut Adapter
FAB - 946	Fabrication Kit
	Dummy





# FABRICATION KIT PARTS LIST

## FAB 946



FKS-16  
4 6mm x35mm Studs



FKN-16  
4 6mm Hex Nuts

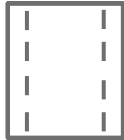

FKB-16A  
1 1 3/4 White Sleeve



FKB-16  
1 5/16" x 3" Anchor Bolt

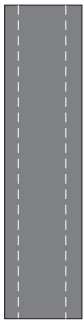

FKS-16A  
1 1/4" ID x 2" Plastic Spacer Material



FKW-16  
4 1/4 Flat Washers

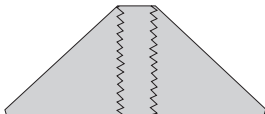

FKA-16  
1 Alignment Cone



LDN694A  
1 Housing Removal Wrench  
Blue Aluminum

# VACUUM INTEGRATED PUMP

## VIP

Activity Levels



VIP is an air expulsion integrated pump for elevated vacuum for prosthetic socket. The use of VIP provides patients continuous total contact when donning the prosthesis. This is essential for an even weight distribution and to distribute the suspension of the prosthesis over the whole surface of the residual limb. Elevated vacuum created by the VIP stabilizes the residual limb, overcoming all issues connected with the residual limb changing volume during the day.

### Features and Applications:

- ALPS VIP is available with 2 different vacuum levels:
  - Elevated Low Vacuum (up to 5mm mercury)
  - Elevated High Vacuum (up to 10mm mercury)
- Easy to install in the prosthetic socket
- It does not require the use of batteries or other power sources, and the need for pistons and cylinders to pump air out of the socket
- Quiet, light and doesn't affect the cosmetic appearance of the prosthesis
- For laminated or thermoplastic sockets



### Product Number

VIP - DL	VIP - Low Vacuum, Convex (Green)
VIP - DH	VIP - High Vacuum, Convex (Red)
VE319 - D	VIP Dummy
VE319 - SD	VIP Small Dummy
VE819 - P	VIP/VIP-Lock Mounting Plate
VIP-L1120-S	VIP Lock Small
LMV-009	Mini Valve Kit ( <i>Highly Recommended</i> )

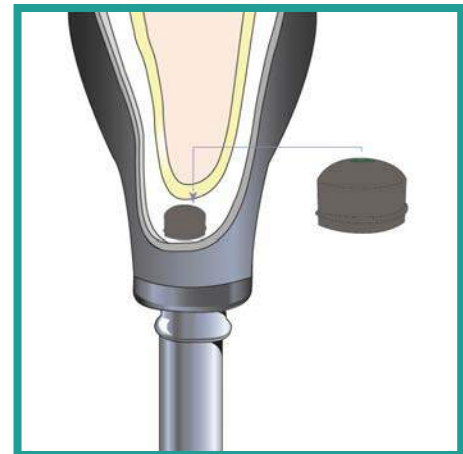

Covered by one or more of the following US Patent No.  
8,197,555 B2



Tel: 727-528-8566 | 800-574-5426 | [www.easyliner.com](http://www.easyliner.com)



# ANTIOXIDANT CREAM

## ANT-CP50

ALPS Antioxidant Cream contains antioxidants that are effective scavengers of free radicals and hydroxyl groups. May assist with soothing pain, itchiness and irritated skin. Can be applied on residual limbs with sensitive skin as it stimulates skin regeneration process. Its moisturizing power improves skin elasticity. Recommended for use with all liners.



### Product Number

ANT - C50 Antioxidant Cream, 50ml  
ANT - C50 BX12 Antioxidant Cream, 50ml Box of 12

**Covered by one or more of the following US Patent No.  
10,543,167**

# PROSTHETIC ANTI-PERSPIRANT

## ATP008

The first anti-perspirant truly designed for prosthetics. Created to help manage the continuing problem of perspiration, it has been formulated with twice the Aluminum Chlorohydrate found in over the counter anti-perspirants. Recommended for use with all liners.



### Product Number

ATP008 Prosthetic Anti-Perspirant, 4 oz.  
ATP008 BX12 Prosthetic Anti-Perspirant, 4 oz. Box of 12



Tel: 727-528-8566 | 800-574-5426 | [www.easyliner.com](http://www.easyliner.com)



# PROSTHETIC CLEANSER

## PD595

ALPS Prosthetic Cleanser is a non-alkaline, soap-free cleanser which can be used for either hand or machine washing of prosthetic liners or sleeves. Patients with sensitive skin may also find that this soothing cleansing agent is ideal for washing skin areas that come into contact with the prosthesis. Recommended for use with all liners.

---

### Product Number

PD595	Prosthetic Cleanser, 16 oz.
PD595 BX12	Prosthetic Cleanser, 16 oz. Box of 12



# PROSTHETIC LUBRICANT

## PA604

ALPS Prosthetic Lubricant is used to help in donning gel and silicone prosthetic liners. It allows the amputee to don the liner or sheath easily while eliminating the sticky feel. Recommended for use with all liners.

---

### Product Number

PA604	Prosthetic Lubricant, 15 oz.
PA604 BX12	Prosthetic Lubricant, 15 oz. Box of 12



# PROSTHETIC OINTMENT

## PO840

ALPS Prosthetic Ointment is a vitamin A and D formulation that soothes and protects the skin. It may be applied nightly after the prosthesis has been removed. Ideal for amputees with sensitive skin or irritation. **May not be used while wearing ALPS Gel Products.** Recommended for use with Silicone-CLEARPRO and Urethane.



### Product Number

PO840	Prosthetic Ointment, 4 oz.
PO840 BX12	Prosthetic Ointment, 4 oz. Box of 12

# SKIN LOTION

## SL108

ALPS 100% Silicone Skin Lotion helps to soothe dry, sensitive skin. It is hypoallergenic, with no perfumes or dyes, and does not leave an oily feeling after use. Can be used sparingly to relieve dry, chapped skin conditions. Recommended for use with all liners.



### Product Number

SL108	Prosthetic Skin Lotion, 4 oz.
SL108 BX12	Prosthetic Skin Lotion, 4 oz. Box of 12
SL108 - 32	Prosthetic Skin Lotion, 32 oz.
SL108 - S	Prosthetic Skin Lotion, 1 oz.
SL108 - S BX 6	Prosthetic Skin Lotion, 1 oz. Box of 6
SL108 - S BX 24	Prosthetic Skin Lotion, 1 oz. Box of 24



Tel: 727-528-8566 | 800-574-5426 | [www.easyliner.com](http://www.easyliner.com)



# EASYSKIN

## TSK

Activity Levels



ALPS cosmetic covers are pre-stretched and are heated to shrink to size. After pulling skin over prosthesis, use a heat gun to start at the toes and work up to the proximal trim. If needed, a vinyl contact cement can be used or super glue for a permanent bond. Can be used on transtibial amputees. For use with suction suspension applications, place a small hole so the cosmetic cover does not inflate.



### Features and Applications:

- Highly comfortable
- Two sizes to accommodate most users
- Pre-Stretched, heat shrink to fit
- No transition line at the ankle

### Sizing Chart

SMALL	Foot length	Ankle	Calf
Minimum	18 cm	17 cm	25 cm
Maximum	23 cm	22 cm	35 cm
LARGE	Foot length	Ankle	Calf
Minimum	23 cm	22 cm	35 cm
Maximum	30 cm	29 cm	45 cm

### Product Number

TSK - X - L                      EasySkin, Large  
 TSK - X - S                      EasySkin, Small

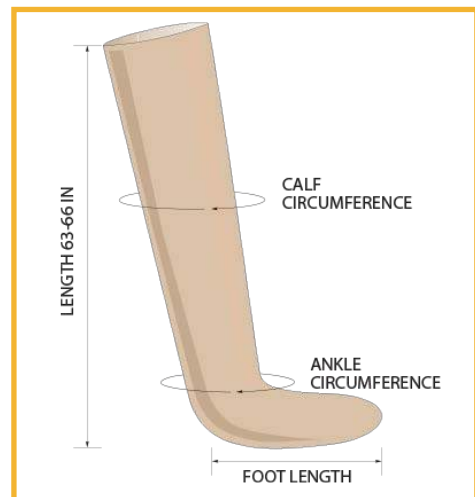

3

5

7

9

11

12

13

US Patent No. 6,911,049



Tel: 727-528-8566 | 800-574-5426 | [www.easyliner.com](http://www.easyliner.com)



# PADSIL

## PDS

### Activity Levels



The PadSil was developed to increase patient comfort in combination with ALPS liners. By increasing distal pressure and enhancing vascular function in distal tissues, the more active amputees will appreciate the additional cushioning, softness, and durability. Users who experience volume changes will also appreciate the PadSils ability to lift the limb back into the proper position.

### Features and Applications:

- Soft medical grade silicone
- Keeps its shape over time
- Helps maintain total contact
- Can be modified



### Sizing Chart

Measured Size	PadSil	Thickness	Circumference
14-19 cm	PDS-S	5/8	6cm
20-23 cm	PDS-M	5/8	7cm
24-27 cm	PDS-L	3/4	8/9cm
28-31 cm	PDS-XL	7/8	10cm
32-35 cm	PDS-XXL	7/8	11-11 1/2 cm

### Product Number

- PDS - XX                      Silicone Distal Pad  
 PDSB - XX                  Blue Dummy Distal Pad

\*XX indicates size

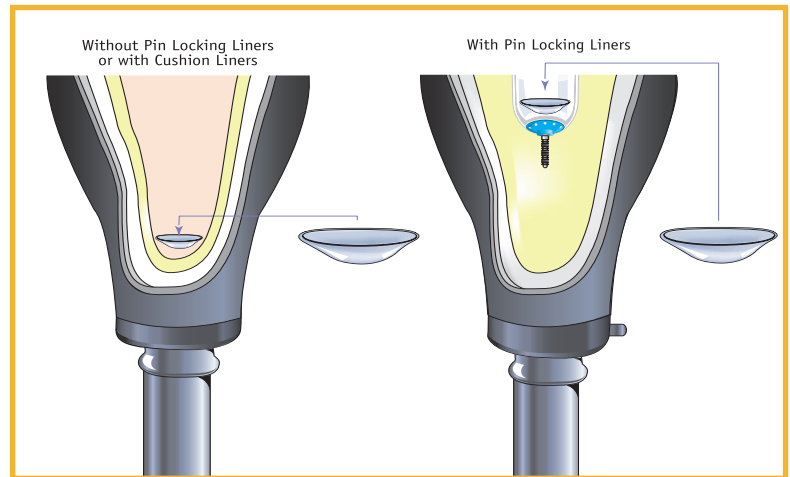

Measure the circumference of the residual limb at 6 cm above the distal end. Use the chart to select the size of the PadSil.



# PROSTHETIC SOCKS

## KCN / KCM / KCW

### Activity Levels



The ALPS prosthetic sock is lightweight and soft, providing cushioning and comfort for a superior fit. Available in 1, 3, and 5 ply, the socks are manufactured with Coolmax® fibers to create a moisture management system which moves perspiration away from the body and through the fabric, where it can evaporate quickly. They accommodate volume fluctuation and can be worn alone or with ones prosthesis.



### Features and Applications:

- Coolmax® fibers allow a cool, comfortable wear
- Keeps its shape over time; minimal stretch and will not mat down
- The plastic reinforced hole prevents fraying of the seam around the distal hole
- Also available for purchase in bundles. See sales representative for details on all available bundle options.

### Product Number

KCN-XX-XX Narrow Socks, Reinforced Hole, Hole, or No Hole  
 KCM-XX-XX Medium Socks, Reinforced Hole, Hole, or No Hole  
 KCW-XX-XX Wide Socks, Reinforced Hole, Hole, or No Hole  
 XX-X-BUNDLE Bundle Socks, Reinforced Hole, Hole, or No Hole

\*XX indicates size

### Sizing Chart

Part Number**	Size / Description	Length of the socket (+5cm)	Distal circumference (at 5cm)	Recommended Alps liner size
KCN 08-(1/3/5) (HR/H/N)	Narrow, Extra Short, 20 cm	20-26 cm	20-23 cm	20
KCN 10-(1/3/5) (HR/H/N)	Narrow, Short 25 cm	26-36 cm	20-23 cm	20
KCN 14-(1/3/5) (HR/H/N)	Narrow, Regular 35 cm	36-46 cm	20-23 cm	20
KCN 18-(1/3/5) (HR/H/N)	Narrow, Long 45 cm	46-60 cm	20-23 cm	20
KCM 08-(1/3/5) (HR/H/N)	Medium, Extra Short, 20 cm	20-26 cm	23-31 cm	24, 26, 28
KCM 10-(1/3/5) (HR/H/N)	Medium, Short 25 cm	26-36 cm	23-31 cm	24, 26, 28
KCM 14-(1/3/5) (HR/H/N)	Medium, Regular, 35 cm	36-46 cm	23-31 cm	24, 26, 28
KCM 18-(1/3/5) (HR/H/N)	Medium, Long, 45 cm	46-60 cm	23-31 cm	24, 26, 28
KCW 08-(1/3/5) (HR/H/N)	Wide, Extra Short, 20 cm	20-26 cm	31-36 cm	32, 38
KCW 10-(1/3/5) (HR/H/N)	Wide, Short, 25 cm	26-36 cm	31-36 cm	32, 38
KCW 14-(1/3/5) (HR/H/N)	Wide, Regular, 35 cm	36-46 cm	31-36 cm	32, 38
KCW 18-(1/3/5) (HR/H/N)	Wide, Long, 45 cm	46-60 cm	31-36 cm	32, 38



Tel: 727-528-8566 | 800-574-5426 | [www.easyliner.com](http://www.easyliner.com)





# SKIN RELIEVER

## ENCP

### Features



Sensitive Skin

### Activity Levels



The ALPS Skin Reliever eliminates shear forces, frictions, and prevents abrasions on the skin of the residual limb. It also accommodates volume fluctuations over the life of the prosthesis. There is no need to make a new socket, ALPS Skin Reliever can be worn under silicone, gel, and pelite liners.

### Features and Applications:

- Reduces shearing and abrasions
- High elasticity
- Replaces socks
- Softens and soothes the skin
- Contains antioxidants for use on delicate skin



### Sizing Chart

Measured Size	3/1.5 mm	Length
10-19 cm	ENCP16	11.5 in-12.5 in
20-27 cm	ENCP20	11.5 in-12.5 in
28-37 cm	ENCP28	11.5 in-12.5 in

Measure the circumference of the residual limb at 6 cm above the distal end.

Use the chart to select the size of the Skin Reliever.

### Product Number

ENCP - XX Skin Reliever, Tapered from 3mm - 1.5mm

\*XX indicates size



US Patent No. 7,709,570



Tel: 727-528-8566 | 800-574-5426 | [www.easyliner.com](http://www.easyliner.com)



# ANKLE BRACE

## ABS

The ALPS Ankle Brace is constructed of neoprene fabric and comes with two attached support straps. Integrated plastic stays on each side of the ankle to ensure stability.

### Features and Applications:

- Soft neoprene blend provides warmth and gentle compression
- Hook and Loop strap for easy on and off
- Protects sprained ankles
- Bilateral stays on both sides, controls eversion without restricting normal range of motion
- Adjustable tension straps have the functionality of an athletic figure 8 bandage
- Fits right or left
- Latex Free



### Sizing Chart

Size	Measured Size Inches	Measured Size Centimeters
Small	11-12	27.9-30.5
Medium	12-13	30.6-33.0
Large	13-14	33.1-35.6
X-Large	14-15	35.7-38.1

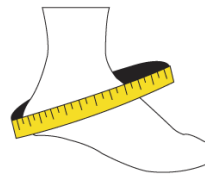

\* Measure the circumference of the ankle at widest point.

### Product Number

ABS - X Ankle Brace

\*X indicates size



Tel: 727-528-8566 | 800-574-5426 | [www.easyliner.com](http://www.easyliner.com)



# BACK BRACE

## BB04

The ALPS BB04 Back Support helps guard against back strains, sprains, and muscle spasms. The neoprene fabric allows for therapeutic warmth to the lumbar region. The brace is incorporated with four removable plastic stays to prevent rollover and allow for strength and stability.

### Features and Applications:

- Lightweight and comfortable
- Four removable stays along the backside
- Simple Hook and Loop Closure allows for easy application
- Added tension straps to provide additional compression and support
- Removable Lumbar Pad
- Latex Free



### Sizing Chart

Size	Measured Size Inches	Measured Size Centimeters
Small	24-30	61-76.2
Medium	30-36	76.3-91.4
Large	36-42	91.5-106.7
X-Large	42-50	106.8-127
XX-Large	50-56	127.1-142.2

### Product Number

BB04 - XX Back Brace

\*XX indicates size



Tel: 727-528-8566 | 800-574-5426 | [www.easyliner.com](http://www.easyliner.com)



# BACK BRACE

## BB06

The ALPS Ventilated Elastic Back Support helps prevent and relieve lower back pain resulting from muscle spasms and strains. It provides support and compression to the lower lumbar and abdominal regions. Integrated plastic stays along backside to ensure stability.

### Features and Applications:

- Cool, lightweight, and comfortable
- Seven lateral stays incorporated
- Ideal for post abdominal surgery
- Added tension straps for more support
- Hides well under clothing
- Latex Free



Size	Measured Size Inches	Measured Size Centimeters
Small	24.5-29.4	62.2-74.7
Medium	29.5-34.9	75.0-88.6
Large	35.0-39.9	88.9-101.3
X-Large	40.0-45.9	101.6-116.6
XX-Large	46.0-52.0	116.8-132.1

\* Measurements taken at center of the waist

### Product Number

BB06 - XX Back Brace

\*XX indicates size



Tel: 727-528-8566 | 800-574-5426 | [www.easyliner.com](http://www.easyliner.com)



# BACK BRACE

## BB08

The ALPS BB08 Back Support helps prevent and relieve lower back pain resulting from muscle spasms and strains. It provides support and compression to the lower lumbar and abdominal regions. Integrated plastic stays along backside to ensure stability. Stays are removable if needed.

### Features and Applications:

- Lightweight and comfortable
- Four removable lateral stays along the backside
- Simple Hook and Loop Closure allows for easy application
- Adjustable tension straps to provide additional compression and support
- Removable Lumbar Pad
- \*Contains Latex



### Sizing Chart

Size	Measured Size Inches	Measured Size Centimeters
Small	25.0-30.5	63.0-77.4
Medium	30.5-35.0	77.5-88.9
Large	35.0-40.5	89.0-102.8
X-Large	40.5-46.0	102.9-116.8
XX-Large	46.0-52.0	116.9-132.1

\* Measurements taken at center of the waist

### Product Number

BB08 - XX Back Brace

\*XX indicates size



Tel: 727-528-8566 | 800-574-5426 | [www.easyliner.com](http://www.easyliner.com)



# COOLFIT EXTENDED KNEE BRACE

## FIT

The ALPS Coolfit Knee Brace is constructed with breathable fabric and is designed to prevent or reduce the severity of a knee injury. The Coolfit is manufactured longer in length than our standard braces and is available in pull-on and wrap-around styles.

### Features and Applications:

- Coolfit breathable fabric allows for improved air circulation
- Works well for patients who are allergic to neoprene knee braces
- Hinges with flexion or extension adjustment
- Medial and lateral support
- Four adjustable velcro straps to ensure stability
- Latex Free
- Length is 14.5 - 15 inches

### Sizing Chart

Size	Measured Size Inches	Measured Size Centimeters
X-Small*	11.0-13.0	28.0-33.0
Small	13.5-15.0	34.3-38.1
Medium	15.5-17.0	39.4-43.2
Large	17.5-22.0	44.5-55.9
X-Large	22.5-24.0	57.2-61.0
XX-Large	24.5-27.0	62.2-68.6
XXX-Large	27.5-30.0	69.9-76.2

\* Size XS - Limited, Check availability with Customer Service

\* Measure four inches (10cm) above the top of the kneecap while standing

### Product Number

FIT - HP - XX Coolfit Knee Brace, Pull-on with Hinge

FIT - HW - XX Coolfit Knee Brace, Wrap Around with Hinge

\*XX indicates size



Tel: 727-528-8566 | 800-574-5426 | [www.easyliner.com](http://www.easyliner.com)



# COOLFIT KNEE BRACE

## CFB

The ALPS Coolfit Knee Brace is constructed with breathable fabric and is designed to prevent or reduce the severity of a knee injury. The Coolfit is available in pull-on and wrap-around style.

### Features and Applications:

- Coolfit breathable fabric allows for air circulation
- Works well for patients who are allergic to neoprene knee braces
- Hinges with flexion or extension adjustment
- Medial and lateral support
- Latex Free
- Length is 13-14 inches

### Sizing Chart

Size	Measured Size Inches	Measured Size Centimeters
X-Small*	11.0-13.0	28.0-33.0
Small	13.5-15.0	34.3-38.1
Medium	15.5-17.0	39.4-43.2
Large	17.5-22.0	44.5-55.9
X-Large	22.5-24.0	57.2-61.0
XX-Large	24.5-27.0	62.2-68.6
XXX-Large	27.5-30.0	69.9-76.2

\* Size XS - Limited, Check availability with Customer Service

\* Measure four inches (10cm) above the top of the kneecap while standing

### Product Number

CFB - HP - XX Coolfit Knee Brace, Pull-on with Hinge

CFB - HW - XX Coolfit Knee Brace, Wrap Around with Hinge

\*XX indicates size



Tel: 727-528-8566 | 800-574-5426 | [www.easyliner.com](http://www.easyliner.com)



# KNEE BRACE

## KBP / KBW

The ALPS knee Brace is constructed of neoprene fabric without adjustable hinges. The brace is designed to prevent or reduce the severity of a knee injury. It is available in a pull-on or wrap-around style.

### Features and Applications:

- Airslots behind the knee
- Neoprene fabric
- Provides compression and warmth
- Latex Free
- Length is 13 inches

### Sizing Chart

Size	Measured Size Inches	Measured Size Centimeters
X-Small*	11.0-13.0	28.0-33.0
Small	13.5-15.0	34.3-38.1
Medium	15.5-17.0	39.4-43.2
Large	17.5-22.0	44.5-55.9
X-Large	22.5-24.0	57.2-61.0
XX-Large	24.5-27.0	62.2-68.6
XXX-Large	27.5-30.0	69.9-76.2

\* Size XS - Limited, Check availability with Customer Service

\* Measure four inches (10cm) above the top of the kneecap while standing

### Product Number

KBP - XX      Knee Brace, Pull-on without Hinge  
KBW - XX      Knee Brace, Wrap Around without Hinge

\*XX indicates size





# KNEE BRACE

## KBHP / KBHW

The ALPS knee Brace is constructed of neoprene fabric with adjustable hinges. The brace is designed to prevent or reduce the severity of a knee injury. It is available in a pull-on or wrap-around style.

### Features and Applications:

- Hinges with flexion or extension adjustment
- Medial and lateral support
- Airslots behind the knee
- Neoprene fabric
- Latex Free
- Length is 13 inches

### Sizing Chart

Size	Measured Size Inches	Measured Size Centimeters
X-Small*	11.0-13.0	28.0-33.0
Small	13.5-15.0	34.3-38.1
Medium	15.5-17.0	39.4-43.2
Large	17.5-22.0	44.5-55.9
X-Large	22.5-24.0	57.2-61.0
XX-Large	24.5-27.0	62.2-68.6
XXX-Large	27.5-30.0	69.9-76.2

\* Size XS - Limited, Check availability with Customer Service

\* Measure four inches (10cm) above the top of the kneecap while standing

### Product Number

KBHP - XX Knee Brace, Pull-on Without Hinge  
KBHW - XX Knee Brace, Wrap Around Without Hinge

\*XX indicates size



Tel: 727-528-8566 | 800-574-5426 | [www.easyliner.com](http://www.easyliner.com)



# THUMB BRACE

## TB

The ALPS Thumb Brace restricts motion to the wrist, thumb, and metacarpal joints following surgery or injury. The thumb is immobilized in a natural position, relieving pain and helping to prevent re-injury. The brace contains a removable, metal stay on the palmar surface for custom fit and adjustment.

### Features and Applications:

- Lightweight and durable fabric
- Thumb spica supports and protects the thumb
- Adjustable thumb strap enhances ease of application and patient fit
- Soft comfortable inner liner with stretch and support
- Latex Free

### Product Number

- |        |                                     |
|--------|-------------------------------------|
| TB - L | Left Thumb Brace, Universal Sizing  |
| TB - R | Right Thumb Brace, Universal Sizing |



# WRIST BRACE

## WB

The ALPS Wrist Brace restricts motion to the wrist and metacarpal joints following surgery or injury. The wrist is immobilized in a natural position by direct compression, relieving pain and helping to prevent re-injury. The brace contains a removable, malleable palmar stay support for custom fit and adjustment.

### Features and Applications:

- Firm support for sprains and strains
- Provides compression and support
- Highest degree of durability and immobilization
- Soft comfortable inner liner with stretch and support
- Breathable and functional wrist support
- Latex Free



### Product Number

- |        |                                     |
|--------|-------------------------------------|
| WB - L | Left Wrist Brace, Universal Sizing  |
| WB - R | Right Wrist Brace, Universal Sizing |

